

INSTRUCTIONS FOR USE WRIST BLOOD PRESSURE MONITOR MOBILE BASIS

apornorm[®]
die marke der apotheke

No.1
in
the pharmacy



Pulse anomaly
detection



One user with
30 memory
spaces



Blood pressure
scale



Ideal for
travelling



For people aged
12 and over

**CLINICALLY +
PROVEN**

**5 year
warranty²**



¹Source: IQVIA; DTC[®] Report, revenue and sales; 2014-09/2025, as of October 2025; Market: Digital upper arm and wrist blood pressure monitors from the pharmacy. ²The warranty does not cover wear parts, batteries and accessories (the cuff has a two-year functional warranty). The warranty is granted for consumers residing in Germany and Austria. For further warranty conditions, see page 25 of these instructions for use.

A quality brand of

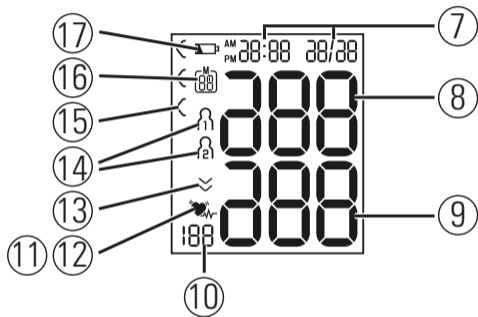
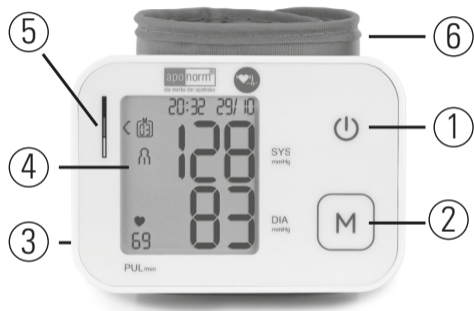



WEPA
DIE APOTHEKENMARKE



Device description

- ① Start/stop button 
- ② Memory button (-button)
- ③ Wrist cuff
- ④ Display
- ⑤ Battery compartment lid
- ⑥ Risk indicator

Information on the display

- ⑦ Time and date
- ⑧ Systolic pressure
- ⑨ Diastolic pressure
- ⑩ Calculated pulse rate
- ⑪ Cardiac arrhythmia symbol 
- ⑫ Pulse symbol 
- ⑬ Release air (arrow)
- ⑭ User memory  / 
- ⑮ Risk indicator
- ⑯ Memory space number/
memory display for average value (A), morning (AM), evening (PM)
- ⑰ Battery replacement symbol 

Contents

1. Included in delivery	5	06. Cleaning and maintenance	21
2. Signs and symbols	5	07. Troubleshooting	21
3. Intended Purpose	7	08. Disposal	22
4. Warnings and safety notes	9	09. Technical specifications	24
5. Usage	13	10. Warranty conditions	25
5.1 Initial use	13	11. Reporting serious incidents	27
5.2 Before the blood pressure measurement	15		
5.3 Taking a blood pressure measurement	17		
5.4 Evaluating the results	18		
5.5 Displaying and deleting measured values	20		

1. Included in delivery

Check that the exterior of the cardboard delivery packaging is intact and make sure that all contents are present. Before use, ensure that there is no visible damage to the device and supplied components, and that all packaging material has been removed.

If you have any doubts, do not use the device and contact your retailer or the specified Customer Services address.

- Wrist blood pressure monitor
- Wrist shell cuff 14-19.50 cm
- Instructions for use + warranty card
- Quick start guide
- Blood pressure passport with the “8 golden rules of blood pressure measurement”
- 2 AAA size alkaline batteries
- Storage case

2. Signs and symbols

The following symbols are used on the device, in these instructions for use, on the packaging and on the type plate for the device:

WARNING

Indicates a potentially impending danger. If it is not avoided, death or serious injury will occur.

CAUTION

Indicates a potentially impending danger. If it is not avoided, slight or minor injuries may occur.

HINWEIS

Indicates a potentially harmful situation. If it is not avoided, the device or something in its vicinity may be damaged.



Product information

Note on important information



Observe the instructions

Read the instructions before starting work and/or operating devices or machines



Disposal in accordance with the Waste Electrical and Electronic Equipment EC Directive – WEEE



Do not dispose of batteries containing harmful substances with household waste



Manufacturer



Date of manufacture

CE labelling



This product satisfies the requirements of the applicable European and national directives.



Marking to identify the packaging material.

A = material abbreviation, B = material number:
1–7 = plastics, 20–22 = paper and cardboard



Device protected against foreign objects ≥ 12.5 mm and against water dripping at an angle



The device is suitable for use with direct current only



Unique Device Identifier (UDI)

Identifier for unique product identification



Batch designation



Item number



Serial number



Medical device



Type number



Galvanically isolated applied part (F stands for “floating”); meets the requirements for leakage currents for type B



Temperature range



Humidity range



Atmospheric pressure limitation



Importer



Europe authorised representative

Available formats for the visually impaired

The instructions for use available at www.aponorm.de/bmg-downloads in PDF format can be printed out in enlarged format.



[www.aponorm.de/
bmg-downloads](http://www.aponorm.de/bmg-downloads)

3. Intended Purpose

Intended Use:

The blood pressure monitor (hereinafter, device) is intended for the fully automatic, non-invasive measurement of arterial blood pressure and pulse values on the wrist.

It is designed for self-measurement by adults in a domestic environment.

Intended Users

The blood pressure measurement is suitable for adult users whose wrist circumference is within the range printed on the cuff.

Indikationen

In the event of hypertension or hypotension, the user can independently monitor their blood pressure and pulse values at home. However, the user does not need to be suffering from hypertension or arrhythmia in order to use the device.

Contraindications

⚠ WARNING

- Do not use the blood pressure monitor on newborns, children or pets.
- Persons with reduced physical, sensory or mental capabilities should be supervised by a person responsible for their safety and receive instructions from that person on how to use the device.
- Do not use the device if you are using electrical implants (e.g. pacemakers).
- Do not use the cuff on people who have undergone a mastectomy or who have had their lymph nodes removed.
- Do not place the cuff over wounds as this may cause further injury.
- Make sure that the cuff is not placed on an arm whose arteries or veins are undergoing medical

treatment, e.g. intravascular access or intravascular therapy, or an arteriovenous (AV) shunt.

- Do not use the device on people with allergies or sensitive skin.

Unforeseen side effects

- Skin irritation
- Negative influence on blood circulation

4. Warnings and safety notes

General warnings

WARNING

- The measurements you take are for your information only – they are not a substitute for a medical examination! Discuss your measured values with your doctor and never make your own medical decisions based on them (e.g. regarding medicine doses).
- The device is only intended for the purpose described in these instructions for use. The manufacturer is not liable for damage resulting from improper or incorrect use.
- Using the blood pressure monitor outside your home environment or while on the move (e.g. while travelling in a car, ambulance or helicopter, or while undertaking physical activity such as playing sport) can influence the measurement accuracy and cause incorrect measurements.
- Cardiovascular diseases may lead to incorrect measurements or have a detrimental effect on measurement accuracy.
- If you have any of the following conditions, it is essential you consult your doctor before using the device: Cardiac arrhythmia, circulatory problems, diabetes, pregnancy, pre-eclampsia, hypotension, chills, shaking
- Do not use the device at the same time as other medical electrical devices (ME equipment). This could cause the measuring device to malfunction and/or an inaccurate measurement.
- Do not use the device outside of the specified storage and operating conditions. This could lead to incorrect measurements.

- Only use the cuffs included in delivery or described in these instructions for use with the device. Using a different cuff may lead to inaccurate measurements.
- Note that when inflating the cuff, the functions of the limb affected may be impaired.
- Do not perform measurements more frequently than necessary. Due to the restriction of blood flow, some bruising may occur.
- Blood circulation must not be stopped for an unnecessarily long time during the blood pressure measurement. If the device malfunctions, remove the cuff from the arm.
- Place the cuff on the wrist only. Do not place the cuff on other parts of the body.
- Small parts may present a choking hazard for small children if swallowed. They should therefore always be supervised.
- Keep away from children, pets and pests.
- Keep children away from the packaging material. Risk of suffocation.
- Do not drop, step on or shake the device.
- Do not disassemble the device as this may cause damage, faults and malfunctions.
- Do not modify the device.
- To rule out a difference between sides, the measurement should initially be taken on both arms.
- Never operate the device during maintenance work. Maintenance work includes maintenance, inspection and repair.

General precautions

CAUTION

- The blood pressure monitor is made from precision and electronic components. The accuracy of the measurements and service life of the device depend on its careful handling.
- Protect the device from impacts, moisture, dirt, marked temperature fluctuations and direct sunlight.
- Ensure the device is at room temperature before taking a measurement. If the measuring device has been stored close to the maximum or minimum storage and transport temperatures and is placed in an environment with a temperature of 20 °C, it is recommended that you wait approx. 2 hours before using the measuring device.
- Do not use the device in the vicinity of strong electromagnetic fields and keep it away from radio sys-

tems or mobile telephones.

- We recommend removing the batteries if the device is not going to be used for a prolonged period of time.

Notes on handling batteries

⚠ WARNING

- **Risk of explosion! Risk of fire!** Failure to comply with the following points can result in personal injury or cause overheating, leakage, venting, breakage, explosion, or fire on the battery.
- This device contains non-rechargeable batteries which must not be charged.
- Do not throw batteries into a fire.
- Never charge, forcibly discharge, heat, disassemble, open, crush, deform, encapsulate, or modify batteries.

- Never short-circuit batteries or battery compartment contacts.
- Protect the batteries from direct sunlight, rain, heat, and water.
- Exposure of batteries to an environment with extremely high temperatures or an extremely low air pressure may result in explosion or leakage of flammable liquids and gases.
- Dispose of defective and discharged batteries immediately and properly (see chapter on disposal).
- Do not use modified or damaged batteries.
- Always select the correct battery type.
- Always insert the batteries correctly, taking into account the polarity (+ / -).
- Never mix batteries of different manufacturers, capacities (new and used), size, or type within a device.
- If a battery has leaked, put on protective gloves and clean the battery compartment with a dry cloth.
- If fluid from a battery comes into contact with your skin or eyes, wash the affected areas with water and seek medical assistance.
- Choking hazard! Keep batteries out of the reach of children. Seek medical attention immediately if swallowed. Swallowing them may cause burns, severe internal injuries, and death.
- Never allow children to replace batteries without adult supervision.

CAUTION

- Store batteries in a well-ventilated, dry, and cool place in a non-conductive container in which the batteries cannot be short-circuited to each other or by other metal objects.
- Keep batteries clean and dry.
- Keep batteries away from water.

- If the device is not going to be used for a long period of time, remove the batteries from the battery compartment.

NOTICE

- Do not use rechargeable batteries.

Notes on electromagnetic compatibility



CAUTION

- The device is suitable for use in all environments listed in these instructions for use, including domestic environments.
- The device may not be fully usable in the presence of electromagnetic disturbances. This could result in issues such as error messages or the failure of the display/device.
- Avoid using this device directly next to other devices or stacked on top of other devices, as this could lead to faulty operation. If, however, it is necessary to use the device in the manner stated, this device as well as the other devices must be monitored to ensure they are working properly.
- The use of components other than those specified or provided by the manufacturer of this device can lead to an increase in electromagnetic emissions or a decrease in the device's resistance to electromagnetic interference; this can result in faulty operation.
- Keep portable RF communication devices (including peripheral equipment, such as antenna cables or external antennas) at least 30 cm away from all device parts, including all cables included in delivery.
- Failure to comply with the above can impair the performance of the device.

5. Usage

5.1 Initial use

Inserting the batteries

- Remove the battery compartment cover on the back of the device .
- Insert the batteries (see chapter “Technical specifications”). Insert the batteries, making sure the polarity is correct according to the label .
- Close the battery compartment cover.

If the  symbol is displayed and does not disappear, measurement is no longer possible. Replace all the batteries. Once the batteries have been removed from the device, the date and time must be set again. Any saved measured values are retained.

Adjusting the settings

Make sure that the device's settings have been set correctly so you can make full use of all its functions. Otherwise you will not be able to save your measured values with the date and time and access them later.

There are two different ways to access the settings menu:



- Before initial use and after each time you replace the battery: When inserting batteries into the device, you will be taken to the relevant menu automatically.
- If the batteries have already been inserted: With the device switched off press and hold the START/STOP button  for approx. 5 seconds.

Set these settings in the order shown below:









Press  to confirm your selection each time.

Time format





Time format flashes		Press M  to select the time format
---------------------	---	---

Date

The year flashes		Press M  to select the year
The month flashes:		Press M  to select the month
The day flashes		Press M  to select the day

 If the time format is set to the 12-hour format, the order in which the day and month are displayed is reversed.

Time

The hour flashes		Press M  to select the hour
The minutes flash		Press M  to select the minutes

5.2 Before the blood pressure measurement

General rules when measuring your own blood pressure

- In order to generate an informative profile of changes in your blood pressure that can be used for comparisons, you should measure your blood pressure regularly and always at the same time of day.

- Measure your blood pressure twice a day: once in the morning after getting up and once in the evening.
- Always perform the measurement when you are sufficiently physically rested. Avoid taking measurements at stressful times.
- Do not take a measurement within 30 minutes of eating, drinking, smoking or exercising.
- Before the initial blood pressure measurement, make sure always to rest for about 5 minutes.

- If you want to take several measurements in succession, always make sure that you leave 5 minutes between each measurement.
- Repeat the measurement if you have doubts about the measured value.

Attaching the cuff

You can measure your blood pressure on either arm. Some deviations between the values in the right and

left arm are perfectly normal. Always perform the measurement on the arm with the higher blood pressure values. Consult your doctor about this before starting self-measurement.

- Always measure your blood pressure on the same arm.
 - The device may only be operated with the cuff that was attached when it was delivered.
 - Before using the device, the user should check the fit of the cuff and make sure that their wrist circumference is within the range printed on the cuff.
1. Uncover your wrist. Ensure that the circulation of the arm is not hindered by any tight clothing or similar.
 2. Now place the cuff on your wrist so that the palm of your hand and the device's display are facing upwards **B1**.
 3. Position the cuff so that there is a distance of 1.0 - 1.5 cm between it and the heel of your hand **B2**.

4. Now fasten the cuff firmly around your wrist using the hook-and-loop fastener. Make sure that it fits tightly, but does not cut into your wrist **B3**.

Adopting the correct posture

- Sit in a comfortable upright position when taking the blood pressure measurement. Lean back so that your back is supported.
- Place your arm on a surface **C**.
- Place your feet flat on the ground next to one another.
- The cuff must be level with your heart.
- Stay as still as possible during the measurement and do not talk.

Further guidelines on performing a correct blood pressure measurement can be found at www.aponorm.de/blutdruckmessregeln.



[www.aponorm.de/
blutdruckmessregeln](http://www.aponorm.de/blutdruckmessregeln)

Selecting the user

This device can have up to 2 users with 60 memory spaces each, allowing you to separately save measurements from 2 different people.

If multiple people are using the device, make sure that the correct user has been selected after each measurement:

- To change the user memory, press the memory button **M**.

5.3 Taking a blood pressure measurement

Requirement: cuff attached, user selected.

1. Press **1**. All display elements are briefly displayed. The cuff inflates itself automatically. The measurement process starts. **♥** is displayed as soon as a pulse is detected. To cancel the measurement, press **1**.

2. The systolic pressure, diastolic pressure and pulse measurements are displayed. "Er_" is displayed if the measurement could not be performed properly. In this case, please refer to the "Troubleshooting" section. If necessary, re-attach the cuff after 1 minute.

The device switches off automatically after approx. 1 minute. The value is saved to the selected or most recently used user.

5.4 Evaluating the results

General information about blood pressure

- Blood pressure is the force with which the blood-stream presses against the arterial walls. Arterial blood pressure constantly changes in the course of a cardiac cycle.
- Blood pressure is always stated in the form of two values:

- The highest pressure is the systolic blood pressure. This occurs when the heart muscle contracts and blood is pumped into the blood vessels.

- The lowest pressure is the diastolic blood pressure. This occurs when the heart muscle has completely relaxed again and the heart is filling with blood.

- Fluctuations in blood pressure are normal. Even during repeat measurements, there may be considerable differences between the measured values. One-off or irregular measurements therefore do not provide reliable information about the actual blood pressure. Reliable assessment is only possible when you perform the measurement regularly under comparable conditions.

Cardiac arrhythmia

The device can identify heart rhythm abnormalities during the blood pressure measurement. If  is displayed after the measurement, this indicates that an irregularity has been detected in your pulse.

Repeat the measurement if  is displayed.

When assessing your blood pressure, only use the results that have been recorded without any irregularities in your pulse.

Consult your doctor if  is displayed frequently. Only they can determine, through an examination, whether there is an abnormality.

Risk indicator

Range	Systolic pressure	Diastolic pressure	Classification
1. Black	≥ 135	≥ 85	Too high
2. Grey	130–134	80–84	Elevated
3. White	< 130	< 80	Normal

Quelle: European Society of Hypertension Practice Guidelines for Home Blood Pressure Monitoring. J Hum Hypertens. 2010 Dec;24(12):779-85.

The risk indicator ⑤ ⑮ indicates which category the recorded blood pressure values fall into. If the measured values are in two different categories (e.g.

systolic pressure in the “high normal” range and diastolic pressure in the “normal” range), the risk indicator always indicates the higher range – “high normal” in the example described.

 Note that these default values are for general guidance only, as individual blood pressures may vary.

Please note that self-measurement at home usually results in values lower than those recorded at a doctor’s surgery. Consult your doctor at regular intervals. Only they are able to give you personal target values for controlled blood pressure, particularly if you are receiving medical therapy.

Low blood pressure

WARNING

Low blood pressure (hypotension) can be a health hazard and cause dizziness or fainting. Blood pressure is considered low if systolic and diastolic pressure are below

90/60 mmHG (source: National Health Service, 2023).

Seek medical attention if you suddenly suffer from low blood pressure.

5.5 Displaying and deleting measured values

User

The results of every successful measurement are saved with the date and time. If there are more than 60 saved measurements, the oldest measurement records are deleted. To retrieve the measurement, press the memory button **M**.

Average value

A flashes:	The average value of all this user's saved measured values is displayed.	Press M .
AM flashes:	The average value of the morning measurements for the last 7 days is displayed (morning: 5:00–9:00).	Press M .
PM flashes:	The average value of the evening measurements for the last 7 days is displayed (evening: 18:00–20:00).	

Individual measured values

1. If you press **M** again, the last individual measurement is displayed (in this example, measurement 03).

2. If you press **M** again, you can view the individual measured values.
3. Press **U** to switch the device off again.

Deleting measured values

1. To delete all of a user's measured values, select the corresponding user. "R" flashes on the display, the average value of all this user's saved measured values is displayed.
2. Press and hold **M** button and Start/Stop button **I** simultaneously for approx. 5 seconds. "CLOO" appears on the display. All this user's values are deleted. The device switches off automatically.

6. Cleaning and maintenance

- Clean the device and cuff carefully using only a slightly damp cloth.
- Do not use any cleaning solutions or solvents.
- Under no circumstances hold the device or cuff under water, as this can cause liquid to enter and damage the device and cuff.
- If you store the device and cuff, do not place heavy objects on the device and cuff.
- Remove the batteries if the device is not going to be used for a long period of time.

7. Troubleshooting

Error message	Possible cause	Solution
<i>Er1</i> or <i>Er2</i>	The systolic or diastolic pressure could not be measured.	Please wait one minute and repeat the measurement. Ensure that you do not speak or move during the measurement.
Hi or Lo	The systolic or diastolic pressure is outside of the measurement range.	Please wait one minute and repeat the measurement. Ensure that you do not speak or move during the measurement. If the message is displayed again, you should seek medical assistance and check the accuracy of your procedure.

Error message	Possible cause	Solution
<i>Er3</i> or <i>Er4</i>	The cuff was not attached correctly.	Please observe the information in the chapter on "Attaching the cuff".
<i>Er5</i>	The blood pressure is higher than 300 mmHg for more than 1.5 seconds.	Please wait one minute and repeat the measurement. Ensure that you do not speak or move during the measurement. If the message is displayed again, you should seek medical assistance and check the accuracy of your procedure.
<i>Er6</i>	Pumping up takes longer than 180 seconds.	Please take another measurement to check whether the cuff can be correctly inflated. Please observe the information in the chapter on "Attaching the cuff".

Error message	Possible cause	Solution
ErA, ErD, Er7 or Er8	There is a system or device error.	Please contact customer service.
	The batteries are almost empty.	Insert new batteries into the device.

HINWEIS

Troubleshooting help for the device can also be found in the download area of the product website www.aponorm.de/bmg-downloads.



[www.aponorm.de/
bmg-downloads](http://www.aponorm.de/bmg-downloads)

8. Disposal

Repairing and disposing of the device

- Do not repair or modify the device yourself. Proper operation can no longer be guaranteed in this case.
 - Do not open the device except for the battery compartment. Failure to comply will invalidate the warranty.
 - Repairs must only be carried out by Customer Services or authorised retailers. Before making a complaint, first check the batteries and replace them if necessary.
-  Dahe device must not be disposed of with household waste. Dispose of the device at a suitable local collection or recycling point in your country. Dispose of the device in accordance with EC Directive – WEEE (Waste Electrical and Electronic Equipment). Please contact

the local authorities responsible for waste disposal if you have any questions regarding disposal.

Disposal of the batteries

- Used, completely discharged batteries must not be disposed of with household waste. Dispose of the batteries in specially designated collection boxes, at recycling points or at electronics retailers. You are legally required to dispose of the batteries correctly.
- The codes below are printed on batteries containing harmful substances:
 - Pb = battery contains lead
 - Cd = battery contains cadmium
 - Hg = battery contains mercury



9. Technical specifications

Typ	BC 28
Modell	aponorm® Mobil Basis
Measurement method	Oscillometric, non-invasive blood pressure measurement on the wrist
Measurement range	Cuff pressure 0 – 300 mmHg, systolic pressure 60 – 260 mmHg, diastolic pressure 40 – 199 mmHg, pulse 40 – 180 beats/minute
Display accuracy	Systolic pressure ± 3 mmHg, diastolic pressure ± 3 mmHg, pulse $\pm 5\%$ of the displayed value
Measurement uncertainty	Max. permissible standard deviation according to clinical testing: systolic pressure 8 mmHg, diastolic pressure 8 mmHg
Memory	2 x 60 memory spaces
Dimensions	L 84 mm x W 60 mm x H 29 mm
Weight	89,2 g (without batteries, with cuff)
Cuff size	14 to 19,5 cm wrist circumference
Operating conditions	+10 °C to +40 °C, $\leq 85\%$ relative humidity, 800 - 1050 hPa ambient pressure

Aufbewahrungs- und Transportbedingungen	-20 °C to +50 °C, ≤ 85 % relative humidity (non-condensing)
Power supply	2 x 1,5V  LR03 AAA batteries
Battery life	For approx. 300 measurements, depending on blood pressure and inflation pressure levels
Expected service life	Informationen zur Lebensdauer des Produkts finden Sie auf beurer.com
Classification	Internal power supply, IP22 no AP or APG, continuous operation, type BF applied part

The serial number is located on the device or in the battery compartment.

Technical specifications are subject to change without notification to allow for updates.

- This device conforms with the European standard EN 60601-1-2 (Group 1, Class B, in accordance with CISPR-11, IEC 61000-4-2, IEC 61000-4-3, IEC 61000-4-8) and is subject to particular precau-

tions with regard to electromagnetic compatibility. Please note that portable and mobile HF communication systems may interfere with this device.

- The accuracy of this blood pressure monitor has been carefully checked and developed with regard to a long useful life. If the device is used for commercial medical purposes, it must be regularly tested for accuracy by appropriate means. Precise instructions for checking accuracy may be requested from the service address.
- The blood pressure monitor has been clinically tested in accordance with the requirements of ISO 81060-2.

10. Warranty conditions

We, WEPA Apothekenbedarf GmbH & Co. KG, voluntarily grant consumers residing in Germany and Austria a 5-year warranty on all aponorm® Mobil Basis blood pressure monitors according to the following terms and conditions:

Object and scope of the warranty

The warranty applies to all aponorm® Mobil Basis blood pressure monitors of consumers residing in Germany and Austria. WEPA Apothekenbedarf GmbH & Co. KG guarantees the purchaser that the product is free from material and manufacturing defects. If, despite proper use of the product, a defect occurs within the five-year warranty period, WEPA Apothekenbedarf GmbH & Co. KG will repair the product free of charge or, at its discretion, replace it entirely (excluding transport costs for sending the device).

Exclusions from the guarantee

Claims under this warranty are not valid in the event of damage caused by the customer or third parties as a result of a fall, accident, or improper handling. The same applies to damage caused by leaking batteries or failure to follow the instructions for use. A warranty coverage by WEPA Apothekenbedarf GmbH & Co. KG is also excluded if a defect/damage is attributable to improper repair or other interventions by third parties.

The warranty does not cover wear parts, accessories (e.g. bags, etc.), batteries and the cuff supplied with the product. We provide a 2-year functional warranty on the cuff (airtightness of the bladder).

Term of the warranty

The warranty is valid for a period of 5 years from the date of purchase (warranty period). The date of the purchase receipt or the warranty card filled out by the dealer with the date of purchase is decisive.

The warranty period is not extended by any provision of services under this warranty, especially as it relates to repair or replacement of the device. The warranty period does not start over again in these cases either.

Assertion of warranty claims

The customer may exercise their warranty rights by presenting the defective product and proof of purchase, or a warranty card completed by the dealer, either to WEPA Apothekenbedarf GmbH & Co. KG or to the dealer from whom the product was purchased, within the warranty period.

In the event of a warranty claim, WEPA Apothekenbedarf GmbH & Co. KG will repair the product free of charge or replace it completely at its own discretion (except for the transport costs for sending the device).

If the check reveals that there is no valid warranty claim, the product can be repaired by WEPA Apothekenbedarf GmbH & Co. KG at the customer's expense. In this case, WEPA Apothekenbedarf GmbH & Co. KG shall provide the customer with a cost estimate before carrying out the repair. The customer may then choose to have the product repaired at their own expense or request the return of the unrepaired product. WEPA will not bear any transport costs.

Further rights of the purchaser

WEPA Apothekenbedarf GmbH & Co. KG provides the warranty under the stated conditions. In addition, the customer may be entitled to further legal rights. The customer's contractual and statutory rights, especially statutory warranty rights against the seller of the product, remain unaffected by this warranty.

The warranty is subject to the laws of the Federal Republic of Germany.

11. Reporting serious incidents

If serious incidents occur during the use of the product, such as a deterioration in health or unusual incidents, please report this to WEPA Apothekenbedarf GmbH & Co. KG. You may also report the incident to the competent authority of the respective EU Member State. In the Federal Republic of Germany this is:

Federal Institute for Drugs and Medical Devices
Pharmacovigilance Department
Kurt-Georg-Kiesinger Avenue 3
D-53175 Bonn
Germany
www.bfarm.de

Incidents are considered serious if they have directly or indirectly caused, could cause, or might cause harm

- a) the death of a person,
- b) a temporary or permanent serious deterioration in a person's state of health, or
- c) a serious risk to public health has occurred, could have occurred, or could occur.

For any other questions about the product or for technical support, please contact the customer service via the contact form on the product website www.aponorm.de/kontakt of aponorm®.



Subject to errors and modifications

Product features



Detects irregular heartbeat Indicates if the heart rhythm was irregular during the measurement.



Automatic blood pressure documentation for two

Records 60 measured values for up to two people so that you can easily track them later.



Easy blood pressure assessment

Classifies your blood pressure values on a scale according to international guidelines and automatically calculates the average value of all your measurements stored in the memory.

**CLINICALLY +
PROVEN**

5 year
warranty¹

Meets the highest quality standards

This device has been clinically tested according to one of the world's most comprehensive blood pressure monitor validation protocols (AAMI = Association for the Advancement of Medical Instrumentation). We offer a 5-year warranty on this device¹

¹The warranty does not cover wear parts, batteries and accessories (the cuff has a 2-year functional warranty). The warranty is granted for consumers residing in Germany and Austria. For further warranty conditions, see page 28 of these instructions for use.

www.aponorm.de



Distributed by: WEPA Apothekenbedarf GmbH & Co KG, D-56204 Hillscheid
www.wepa-apothekenbedarf.de

 **ANDON HEALTH CO., LTD.**
No. 3 Jinping Street, Ya An Road
Nankai District, Tianjin, 300190
China

 **Koviva GmbH**
Bahnstraße 16
D-40212
Düsseldorf
Germany



 **iHealthLabs Europe SAS**
36 rue de Ponthieu
75008 Paris
France

Order No.: 048215



PZN -11725048